

Laboratory Bowl - 350 x 350mm



The Veitch Stainless Steel Laboratory Bowls are used in schools and laboratories where corrosive materials are being used. They are an insert bowl that fits into a bench and held down with fixing clips

Technical Data

Product	Laboratory Bowl: 350 x 350
Product Code	03-4036
Material	Gr316 Stainless Steel
Material Thickness	1.2mm
Material Surface Finish	2B Finish
Type of mounting	Insert into benchtop with sink clips
Outlet Size	DN50 (50 BSP)
Flange Width	38mm
Overall Size	425 x 425mm
Bowl Size	350 x 350mm
Overall Depth of Bowl	250mm
Cut out size	405 x 405mm

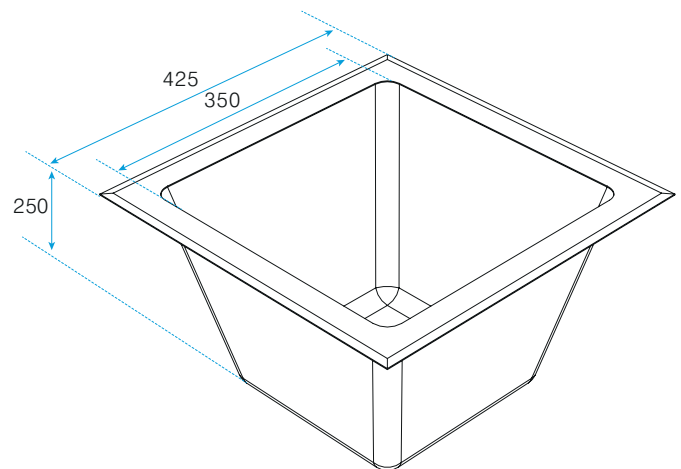

The information in this sheet reflects the current technical specifications at the time of publication. As part of our continuous improvement program, we reserve the right to change the technical or physical specifications without notice.